

**3500 GALLON
GREASE
50" LL
56" INLET**

Single Compartment

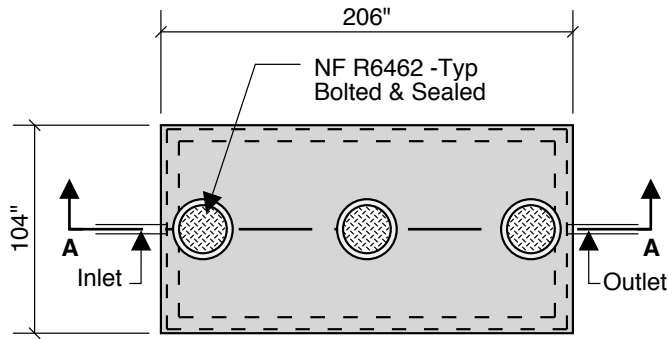

Top View

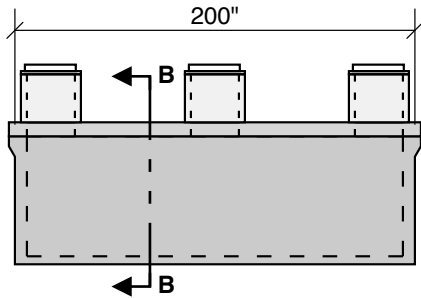

Side View

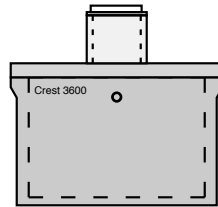

End View

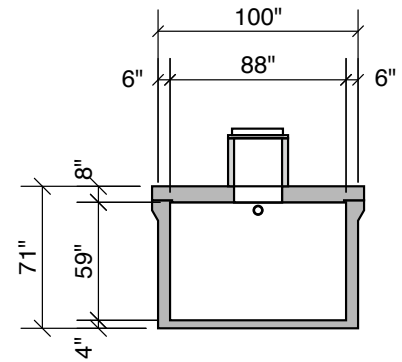

Section B-B

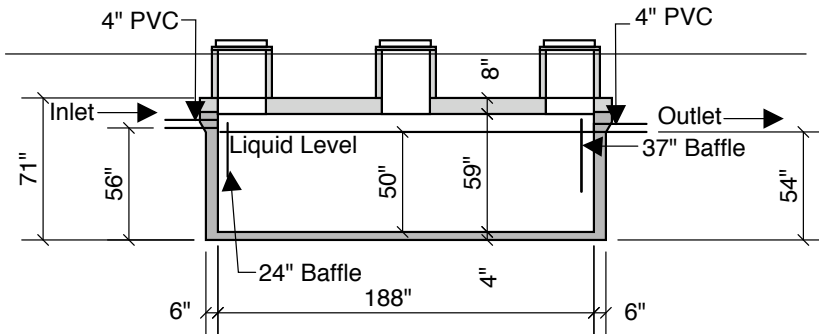

Section A-A

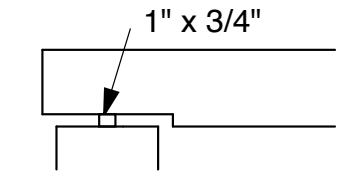

Typical Cover Detail

Notes:
 Concrete - 5000 PSI
 Joint Sealant - High Grade EZ-Stick
 Labels - Warning signs located on all manholes
 Installation - See separate installation guide
 Baffles Installed
 Rubber Gaskets - Press Seal
 Tank Designed To ASTM C-1227-90 and ASTM 1613-06

Crest Precast, Inc.
La Crescent, MN & Barneveld, WI
 800-658-9045

Scale		Drawn By:	KGT
Date	5-1-08	Revision	
Project:	3500 Gal. Grease Interceptor		
Contractor:	MODEL 3500-G		